





## 1 Overview – Solutions for high-speed data transfer, extended network reach, and robust reliability

Designed for enhanced connectivity, Brainboxes Industrial 16 Port Ethernet Switches are a cost-effective solution to streamline installations, simplify maintenance and wiring complexity, and improve efficiency whilst reducing potential points of failure.

Available with **Fast** and **Gigabit Ethernet**, and with **SFP**, all Hero Ethernet switches come in an **industrial hardened metal enclosure** for reliable operation in demanding environments.

### 1.1 Functionality and Features

		WITH SFP	
10/100 ETHERNET	 SW-7016	 SW-7617	<ul style="list-style-type: none"> <li>✓ Enhanced connectivity and flexibility: Higher port count enables flexible network layout and device placement</li> <li>✓ Integrated, adjustable DIN-rail mount with grounding</li> <li>✓ Wide voltage input range (+5V to +30VDC) and dual redundant power inputs - ensures reliability and reduces the risk of power outages</li> <li>✓ Industrial hardened enclosure and wide operating temperature range (-40°C to +80°C / -40°F to +176°F) - reliable operation in harsh environments</li> </ul>
10/100 & GIGABIT ETHERNET	 SW-7416	 SW-7717	

### 1.2 Product Variants

Model	Fast Ethernet	Gigabit	SFP	Enclosure
	10/100 BASE-T (RJ45)	10/100/1000 BASE-T (RJ45)	1000 BASE-X	
SW-7016	16	-	-	Hardened
SW-7416	14	2	-	Hardened
SW-7617	16	-	1	Hardened
SW-7717	14	2	1	Hardened

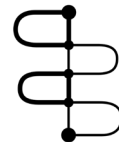

### 1.3 General Information

Model	Power Consumption	Operating Temp	Product Weight	Product Size	GTIN (barcode)	Package Weight	Package Size
<b>SW-7016</b>	3.8 Watts Max: @+5V to +30VDC	-40°C to +80°C -40°F to 176°F	0.53kg 18.68oz	158 x 102 x 43mm 6.22 x 4.02 x 1.69in	837324005196	0.67kg 23.63oz	200 x 140 x 80mm 7.87 x 5.51 x 3.15in
<b>SW-7416</b>	6 Watts Max: @+5V to +30VDC	-40°C to +80°C -40°F to 176°F	0.64kg 22.64oz	180 x 108 x 43mm 7.09 x 4.25 x 1.69in	837324005202	0.75kg 26.46oz	200 x 140 x 80mm 7.87 x 5.51 x 3.15in
<b>SW-7617</b>	7.5 Watts Max: @+5V to +30VDC	-40°C to +80°C -40°F to 176°F	0.64kg 22.64oz	180 x 108 x 43mm 7.09 x 4.25 x 1.69in	837324005219	0.75kg 26.46oz	200 x 140 x 80mm 7.87 x 5.51 x 3.15in
<b>SW-7717</b>	7.5 Watts Max: @+5V to +30VDC	-40°C to +80°C -40°F to 176°F	0.64kg 22.64oz	180 x 108 x 43mm 7.09 x 4.25 x 1.69in	837324005226	0.75kg 26.46oz	200 x 140 x 80mm 7.87 x 5.51 x 3.15in

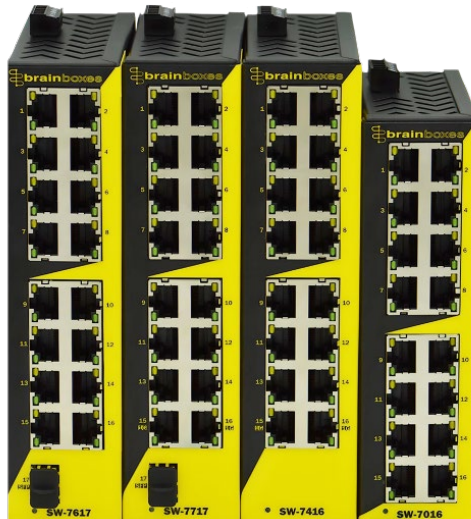



**UK** CAGE NCAGE  
**CA** 8QCY6 U0Q96

**AEO**  
UK Authorised Economic Operator

LIFETIME SUPPORT

LIFETIME WARRANTY

**MADE IN BRITAIN**  

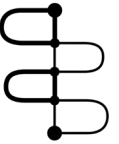
## Contents

1	Overview – Solutions for high-speed data transfer, extended network reach, and robust reliability .....	1
1.1	Functionality and Features.....	1
1.2	Product Variants.....	1
1.3	General Information.....	2
2	Pinouts .....	4
2.1	Ethernet Ports .....	4
2.2	Power Terminal .....	4
3	Enclosures (3D Models Available).....	5
3.1	Hardened (DIN rail mountable metal enclosure).....	5
3.1.1	SW-7016 .....	5
3.1.2	SW-7416 .....	5
3.1.3	SW-7617 & SW-7717 .....	6
4	DIN-Rail Mounting .....	6
5	Data.....	7
5.1	Power Supply .....	7
5.2	Environment.....	7
5.3	LED Information .....	7
5.4	Ethernet .....	8
6	Approvals & Support.....	8
6.1	Industry Approvals .....	8
6.2	Company Approvals .....	8
6.3	Support.....	8
7	Ordering Information.....	9
8	Accessories.....	9
9	Revision History .....	9

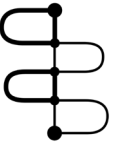

## 2 Pinouts

### 2.1 Ethernet Ports

PIN	ETHERNET	
	10/100 Fast Ethernet	10/100/1000 Gigabit Ethernet
1	Tx+ / Rx+	TxRx A+
2	Tx- / Rx-	TxRx A-
3	Rx+ / Tx+	TxRx B+
4		TxRx C+
5		TxRx C-
6	Rx- / Tx-	TxRx B-
7		TxRx D+
8		TxRx D-

### 2.2 Power Terminal

Pin	Function
1	-V
2	+VA
3	+VB
4	-V
5	FUNC EARTH

Screw Terminals	Wire Thickness	
5 Pin 3.5mm Pitch	Wire Cross Section	0.14mm – 1.5mm
	AWG Value	#28 – #16
	Stripping Length	7mm / 0.27in
	Tightening Torque	0.22Nm – 0.25Nm

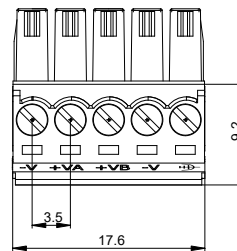
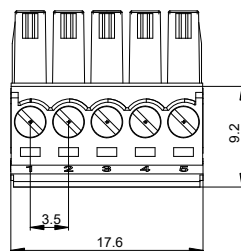
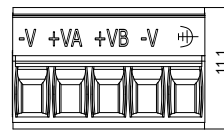
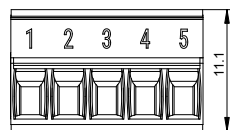

All Dimensions in mm

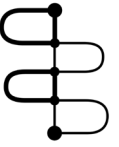

### 3 Enclosures (3D Models Available)

#### 3.1 Hardened (DIN rail mountable metal enclosure)

##### 3.1.1 SW-7016

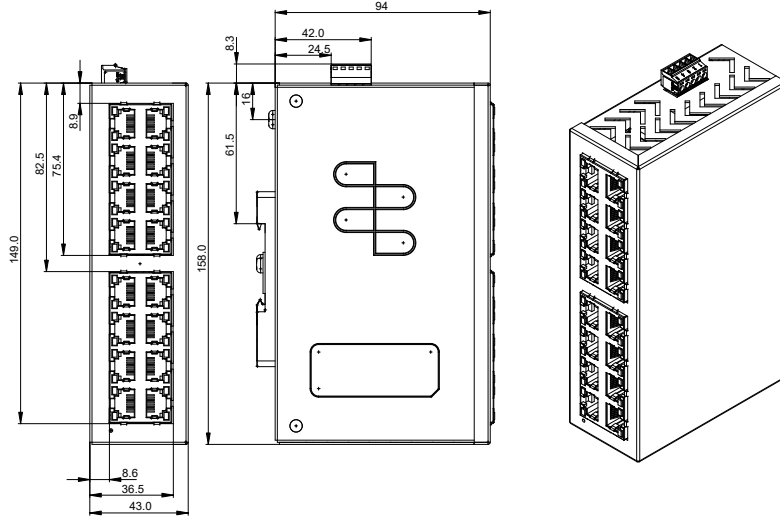

All Dimensions in mm  
Tolerance  $\pm 0.5\text{mm}$  Unless otherwise stated

##### 3.1.2 SW-7416

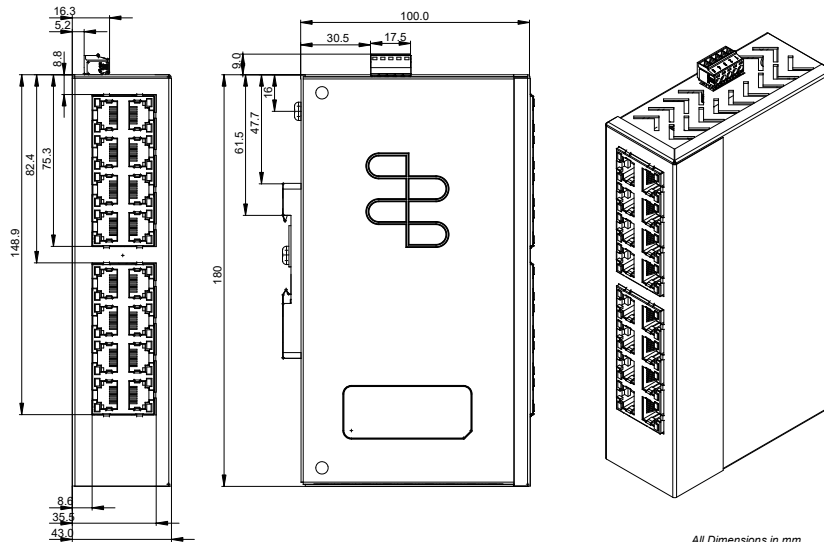

All Dimensions in mm  
Tolerance  $\pm 0.5\text{mm}$  Unless otherwise stated

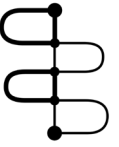

### 3.1.3 SW-7617 & SW-7717

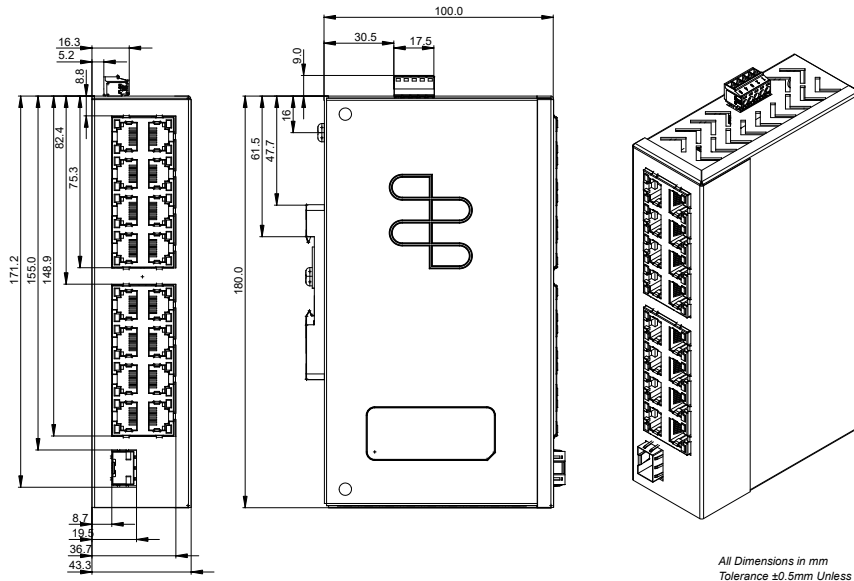

All Dimensions in mm  
Tolerance  $\pm 0.5\text{mm}$  Unless otherwise stated

## 4 DIN-Rail Mounting

All 16 Port switch products come with a MK-103 DIN Rail clip, which depending on your requirements, can be repositioned into 2 different mounting locations and rotated 180°:

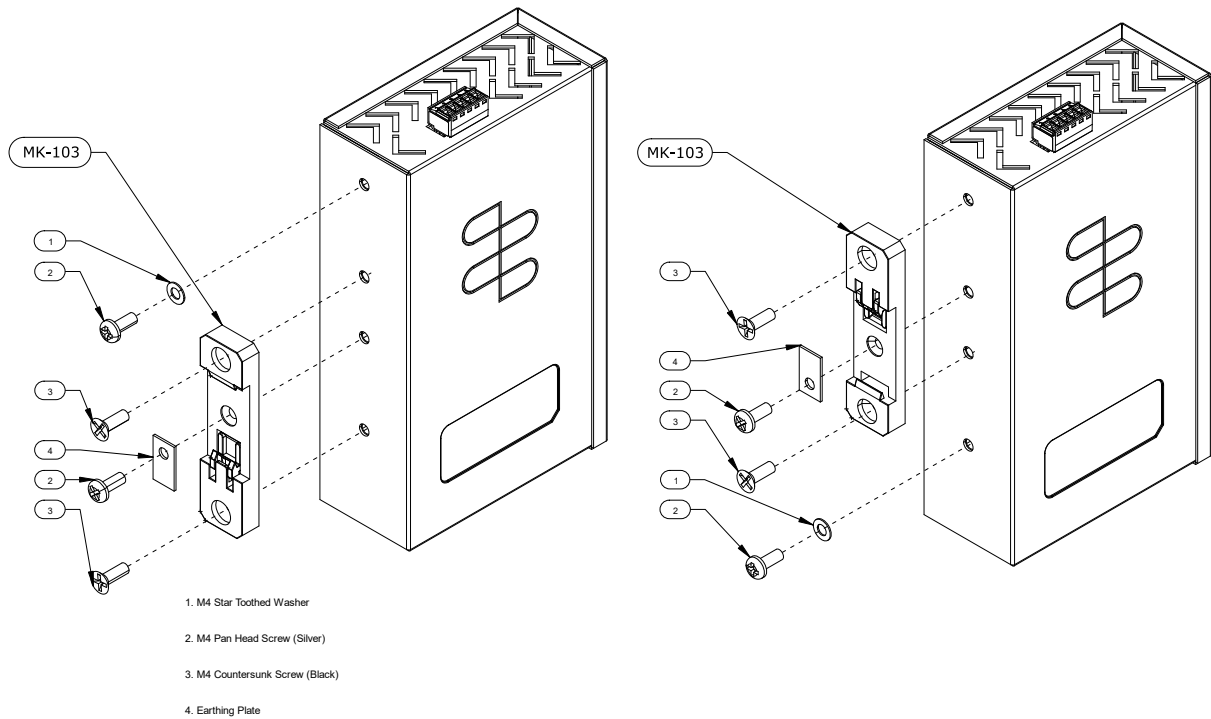

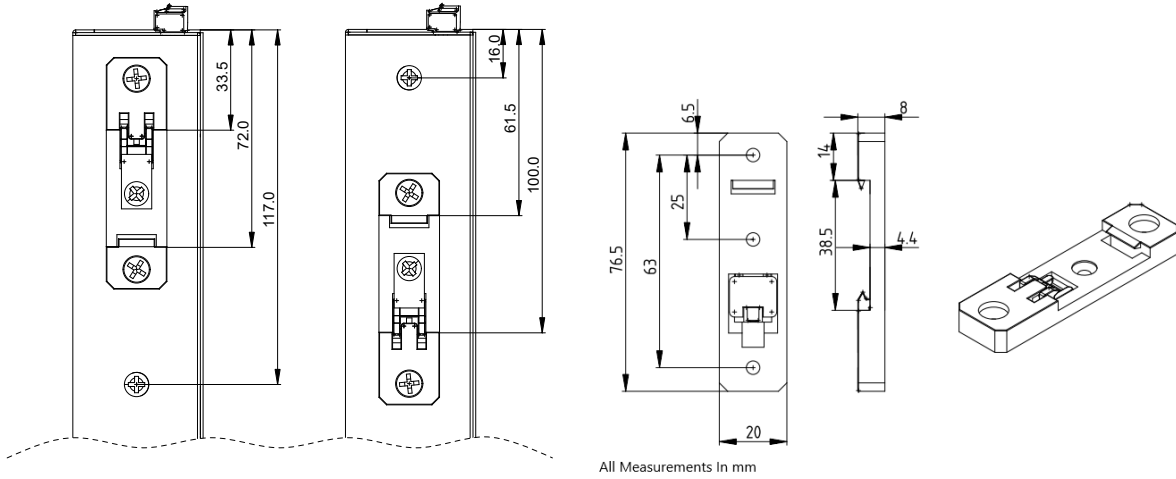
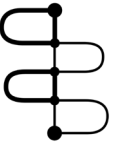

## 5 Data

<b>SFP Overcurrent Protection</b>	1.15W (360mA) Maximum
-----------------------------------	-----------------------

### 5.1 Power Supply

<b>Power Consumption</b>	See Table: 1.3 General Information
<b>Power Supply Input</b>	Unregulated +5V to +30 Volts DC Dual Redundant Power Inputs, Reverse Polarity Protection

### 5.2 Environment

<b>Operating Temperature</b>	-40°C to +80°C / -40°F to +176°F
<b>Storage Temperature</b>	-40°C to +80°C / -40°F to +176°F
<b>Ambient Relative Humidity</b>	5 to 95% (non-condensing)

### 5.3 LED Information

<b>RJ45 LED</b>	<b>Green</b>	Link/Activity
	<b>Yellow</b>	Port Operating at Max Speed
<b>SFP LED</b>	<b>Green</b>	Power On
	<b>Amber</b>	SFP Plugged In
	<b>Amber Flashing</b>	SFP Link / Activity
	<b>Green/Amber Flashing</b>	SFP Error/Incompatible

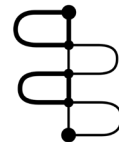

## 5.4 Ethernet

<b>Ethernet Port</b>	Up to 16x 10/100BASE-T(X) RJ45 ports (Auto MDI-X) Up to 2x 10/100/1000BASE-T RJ45 ports Up to 1x 1000BASE-X SFP port All Ports Work Concurrently
<b>Protection</b>	1500VRMS Magnetic Isolation Between RJ45 (Copper Twisted Pair Only)

## 6 Approvals & Support

### 6.1 Industry Approvals

<b>General</b>	WEEE, RoHS, CE, UKCA
<b>UL</b>	METL Complies with UL62368-1
<b>HTS</b>	8517620000
<b>ECCN</b>	5A991.b

### 6.2 Company Approvals

<b>General</b>	ISO9001, ISO14001, Microsoft Certified Gold Partner, AEO (C-TPAT)
<b>CAGE</b>	8QCY6
<b>NCAGE</b>	U0Q96
<b>GSA Contract Number</b>	47QTCA23D009X

### 6.3 Support

<b>Warranty</b>	Lifetime - online registration required
<b>Support</b>	Lifetime web, email and phone support from fully qualified, friendly staff who work in and alongside the Product Development Team
<b>OEM option</b>	Available for bulk buy OEM
<b>COO (Country of Origin)</b>	Made in GB, United Kingdom of Great Britain & Northern Ireland
<b>Customisable</b>	Perfect Fit Custom Design policy for volume users



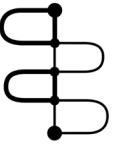

## 7 Ordering Information

Part Number	Description
SW-7016	Hardened Industrial 16x 10/100 Ethernet Switch
SW-7416	Hardened Industrial 14x 10/100 & 2x 1G Ethernet Switch
SW-7617	Hardened Industrial 16x 10/100 & 1x SFP Ethernet Switch
SW-7717	Hardened Industrial 14x 10/100, 2x 1G & 1x SFP Ethernet Switch

## 8 Accessories

- [PW-301](#) – 96W Single Output Industrial DIN Power Supply
- [PW-245](#) – 60W Single Output Industrial DIN Power Supply
- [PW-400](#) – Power Adapter 12V 1.5A Terminal Tails UK/EU/US/AUS Pack

## 9 Revision History

	Approved By
<b>Current Version:</b> 1.1 – 25/09/24	JM
<b>Previous Version:</b> 1.0 – 04/07/24	JM

Version	Changes	Approved By
1.0	Public Release	JM
1.1	Terminology Correction	JM